

Use Cases and Scenarios

Cheng: CSE 435: Software Engineering

© 2007-08 Betty H.C. Cheng. This presentation is available free for non-commercial use with attribution under a creative commons license.

1

We Will Cover

- What is a use-case
 - Use-case versus user interaction
- Use-Case diagrams
 - The constructs in the use-case diagrams
- Capturing the use-case
 - High-level use-case
 - Extended use-case
 - Difference between use case and scenario

Cheng: CSE 435: Software Engineering

© 2007-08 Betty H.C. Cheng. This presentation is available free for non-commercial use with attribution under a creative commons license.

2

What is a Use-Case

- A use-case captures some user visible function
- This may be a large or small function
 - Depends on the level of detail in your modeling effort
- A use-case achieves a discrete goal for the user
- Examples
 - Format a document
 - Request an elevator
- How are the use cases found (captured or elicited)?

Cheng: CSE 435: Software Engineering

© 2007-08 Betty H.C. Cheng. This presentation is available free for non-commercial use with attribution under a creative commons license.

3

User Goals versus User Interactions

- Consider the following when formatting a document
 - Define a style
 - Change a style
 - Copy a style from one document to the next
 - versus
 - Format a document
 - Ensure consistent formatting of two documents
- The latter is a user goal
 - Something the user wants to achieve
- The former are user interactions
 - Things the user does to the system to achieve the goal

Cheng: CSE 435: Software Engineering

© 2007-08 Betty H.C. Cheng. This presentation is available free for non-commercial use with attribution under a creative commons license.

4

Goals and Interactions

- There is a place for both goals and interactions
- Understand *what* the system shall do
 - Capture the user goals
- Understand *how* the user will achieve the goals
 - Capture user interactions
 - Sequences of user interactions
- Thus, start with the user goals and then refine the user goals into several (many) user interactions

Cheng: CSE 435: Software Engineering

© 2007-08 Betty H.C. Cheng. This presentation is available free for non-commercial use with attribution under a creative commons license.

5

Use-Case Diagrams (POST)

POST: Point of Sale Terminal

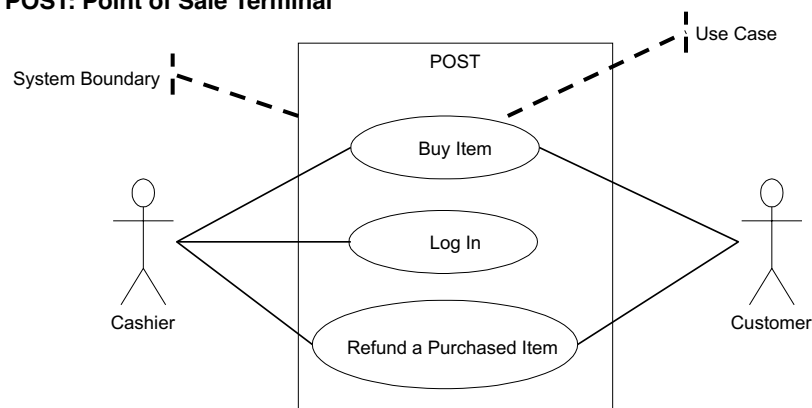

© 2007-08 Betty H.C. Cheng. This presentation is available free for non-commercial use with attribution under a creative commons license.

6

Another Example

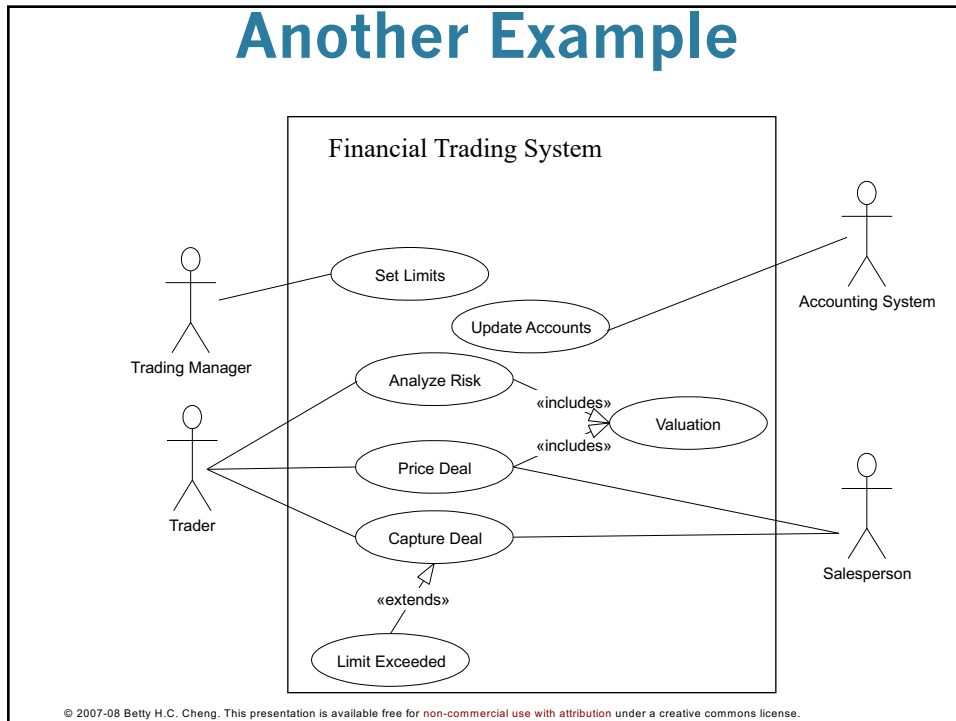

7

Includes and Extends

- Includes
 - You have a piece of behavior that is similar across many use cases
 - Break this out as a separate use-case and let the other ones “includes” it
 - Examples include
 - Valuation
 - Validate user interaction
 - Sanity check on sensor inputs
 - Check for proper authorization
- Extends
 - A use-case is similar to another one but does a little bit more
 - Put the normal behavior in one use-case and the exceptional behavior somewhere else
 - Capture the normal behavior
 - Try to figure out what can go wrong in each step
 - Capture the exceptional cases in separate use-cases
 - Makes it a **lot** easier to understand

Cheng: CSE 435: Software Engineering

© 2007-08 Betty H.C. Cheng. This presentation is available free for non-commercial use with attribution under a creative commons license.

8

Setting the System Boundary

- The system boundary will affect your actors and use-cases

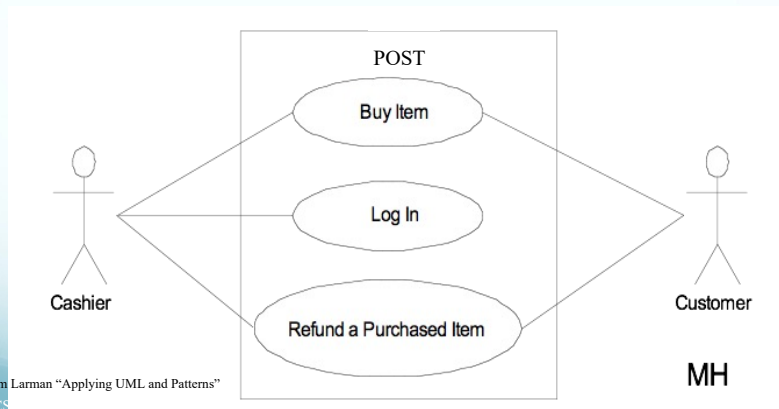

Adapted from Larman "Applying UML and Patterns"
Cheng: CS

© 2007-08 Betty H.C. Cheng. This presentation is available free for non-commercial use with attribution under a creative commons license.

11

A Different Boundary

- Let us view the whole store as our system

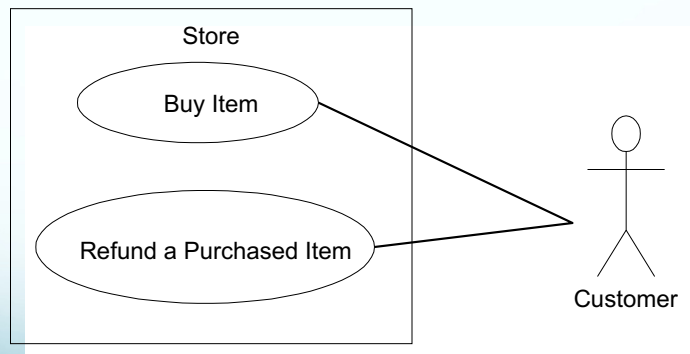

Adapted from Larman "Applying UML and Patterns"
Cheng: CSE 435: Software Engineering

© 2007-08 Betty H.C. Cheng. This presentation is available free for non-commercial use with attribution under a creative commons license.

12

Partial POST

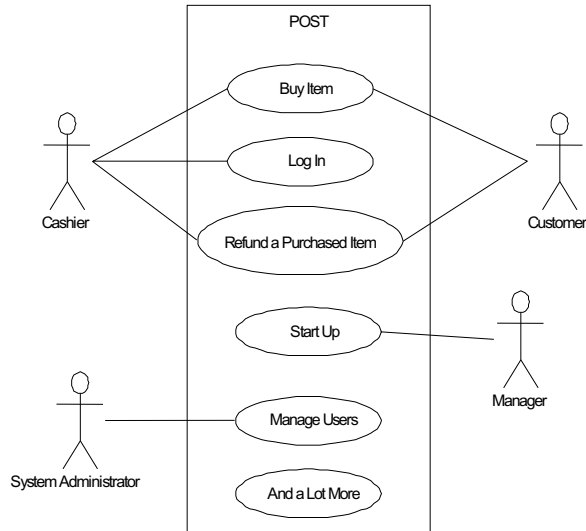

© 2007-08 Betty H.C. Cheng. This presentation is available free for non-commercial use with attribution under a creative commons license.

14

POST Use-Case

Use case: Buy Item

Actors: Customer (initiator), Cashier

Type: Primary

Description: The Customer arrives at the checkout with items to purchase. The Cashier records the purchase items and collects a payment. On completion the Customer leaves with the items

Cheng: CSE 435: Software Engineering

© 2007-08 Betty H.C. Cheng. This presentation is available free for non-commercial use with attribution under a creative commons license.

15

POST Expanded Use-Case

Use case: Buy Item

Actors: Customer (initiator), Cashier

Type: Primary and essential

Description: The Customer arrives at the checkout with items to purchase. The Cashier records the purchase items and collects a payment. On completion the Customer leaves with the items.

Cross Ref.: Requirements XX, YY, and ZZ

Use-Cases: Cashier must have completed the *Log In* use-case

[HERE](#)

Cheng: CSE 435: Software Engineering

© 2007-08 Betty H.C. Cheng. This presentation is available free for non-commercial use with attribution under a creative commons license.

16

Home Heating System

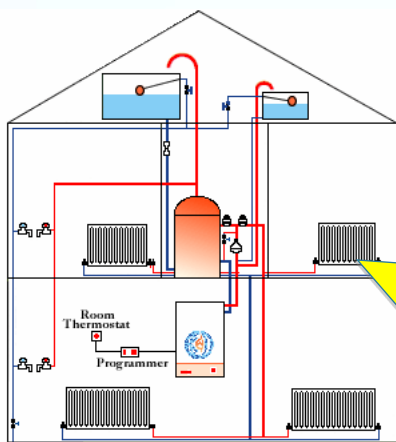

Image: <http://www.heatingoil.com/>

Image: <http://www.homeheatingdr.com/>

Cheng: CSE 435: Software Engineering

© 2007-08 Betty H.C. Cheng. This presentation is available free for non-commercial use with attribution under a creative commons license.

18

Home Heating System

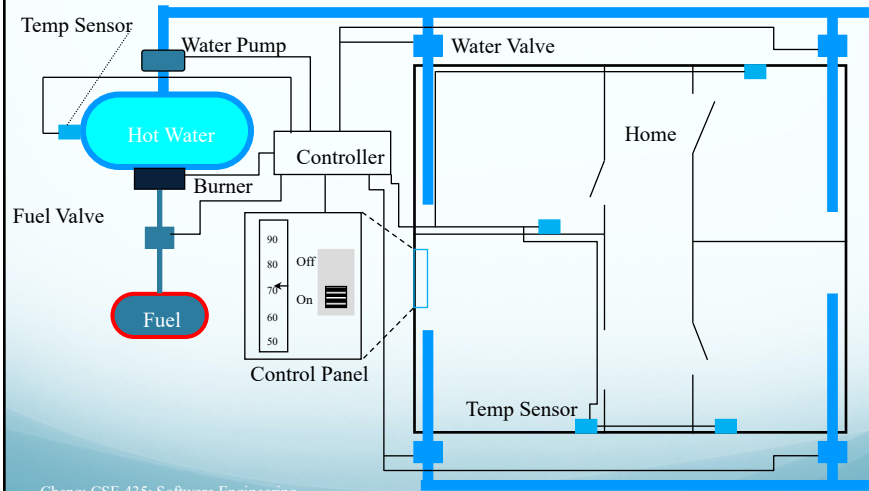

Cheng: CSE 435: Software Engineering

© 2007-08 Betty H.C. Cheng. This presentation is available free for non-commercial use with attribution under a creative commons license.

19

Home Heating Requirements

The purpose of the software for the Home Heating System is to control the heating system that heats the rooms of a house. The software shall maintain the temperature of each room within a specified range by controlling the heat flow to individual rooms.

1. The software shall control the heat in each room
2. The room shall be heated when the temperature is 2F below desired temp
3. The room shall no longer be heated when the temperature is 2F above desired temp
4. The flow of heat to each room shall be individually controlled by opening and closing its water valve
5. The valve shall be open when the room needs heat and closed otherwise
6. The user shall set the desired temperature on the thermostat
7. The operator shall be able to turn the heating system on and off
8. The furnace must not run when the system is off

Cheng: CSE 435: Software Engineering

© 2007-08 Betty H.C. Cheng. This presentation is available free for non-commercial use with attribution under a creative commons license.

20

Home Heating Requirements

The purpose of the software for the Home Heating System is to control the heating system that heats the rooms of a house. The software shall maintain the temperature of each room within a specified range by controlling the heat flow to individual rooms.

9. When the furnace is not running and a room needs heat, the software shall turn the furnace on
10. To turn the furnace on the software shall follow these steps
 - a. open the fuel valve
 - b. turn the burner on
11. The software shall turn the furnace off when heat is no longer needed in any room
12. To turn the furnace off the software shall follow these steps
 - a. close fuel valve
 - b. turn burner off

Cheng: CSE 435: Software Engineering

© 2007-08 Betty H.C. Cheng. This presentation is available free for non-commercial use with attribution under a creative commons license.

21

Home Heating Use-Case Diagram

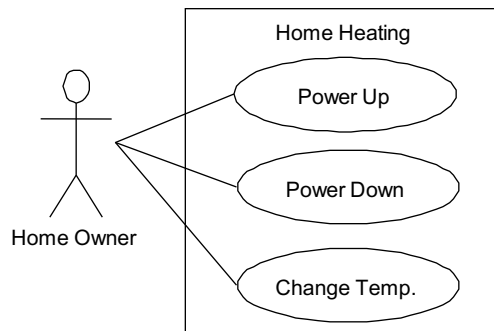

© 2007-08 Betty H.C. Cheng. This presentation is available free for non-commercial use with attribution under a creative commons license.

22

Home Heating Use-Cases

Use case: Power Up
Actors: Home Owner (initiator)
Type: Primary and essential
Description: The Home Owner turns the power on. Each room is temperature checked. If a room is below the the desired temperature the valve for the room is opened, the water pump started. If the water temp falls below threshold, the fuel valve is opened, and the burner ignited. If the temperature in all rooms is above the desired temperature, no actions are taken.

Cross Ref.: Requirements 1, 2, 4, 5, 9, 10a, 10b, etc
Use-Cases: None

Cheng: CSE 435: Software Engineering

© 2007-08 Betty H.C. Cheng. This presentation is available free for non-commercial use with attribution under a creative commons license.

23

Modified Home Heating

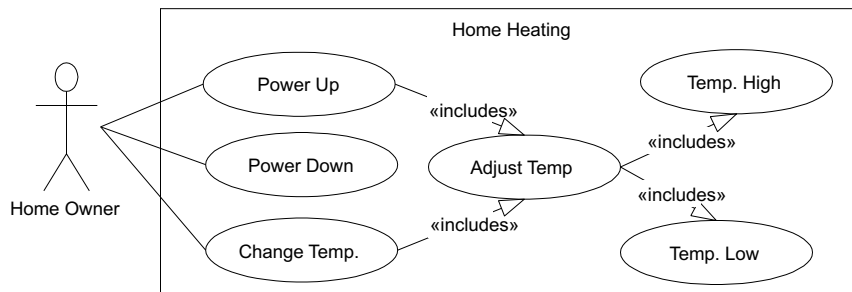

© 2007-08 Betty H.C. Cheng. This presentation is available free for non-commercial use with attribution under a creative commons license.

24

Modified: Home Heating Use-Cases

Use case: Power Up
Actors: Home Owner (initiator)
Type: Primary and essential
Description: The Home Owner turns the power on.
Perform Adjust Temp. If the temperature in all rooms is above the desired temperature, no actions are taken.
Cross Ref.: Requirements 1, 2, 3, 4, 5, 6, 9, 10a, 10b, etc
Use-Cases: Perform Adjust Temp

Cheng: CSE 435: Software Engineering

© 2007-08 Betty H.C. Cheng. This presentation is available free for non-commercial use with attribution under a creative commons license.

25

Modified: Home Heating Use-Cases

Use case: Adjust Temp
Actors: System (initiator)
Type: Secondary and essential
Description: Check the temperature in each room. For each room below target, open room valve, start pump if not started. If water temp falls below threshold, open fuel valve and ignite burner.
Cross Ref.: Requirements 2, 5, 6, 9, 10a, 10b,
Use-Cases: Temp-Low, Temp-high

Cheng: CSE 435: Software Engineering

© 2007-08 Betty H.C. Cheng. This presentation is available free for non-commercial use with attribution under a creative commons license.

26

When to use Use-Cases

- In short, can always be used!!!
- Requirements is the toughest part of software development
 - Use-Cases is a powerful tool to understand
 - Who your users are (including interacting systems)
 - What functions the system shall provide
 - How these functions work at a high level
- Spend adequate time on requirements and in the elaboration phase

Cheng: CSE 435: Software Engineering

© 2007-08 Betty H.C. Cheng. This presentation is available free for non-commercial use with attribution under a creative commons license.

32

In-class Use Case activity

- Discuss and then identify system boundary
- Enumerate 3-5 key high-level services of your system
- Identify candidate external actors
- Google Form:
 - <https://forms.gle/y4rq763Y72QKxKb97>

Cheng: CSE 435: Software Engineering

© 2007-08 Betty H.C. Cheng. This presentation is available free for non-commercial use with attribution under a creative commons license.

33